

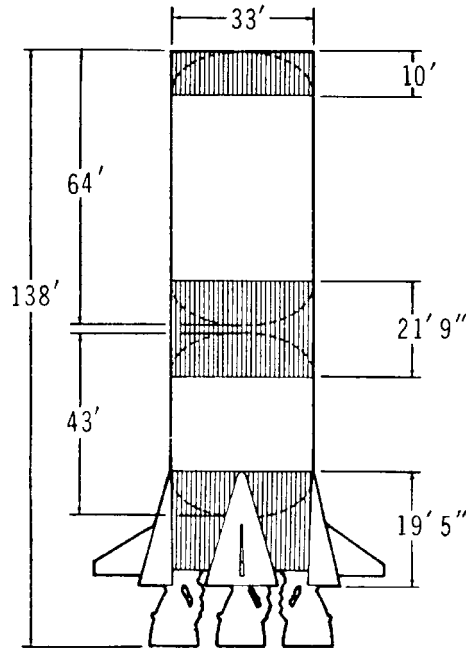

SATURN V NEWS REFERENCE

FIRST STAGE FACT SHEET



WEIGHT: 300,000 lb. (dry)
 4,792,000 lb. (loaded)
 DIAMETER: 33 ft.
 HEIGHT: 138 ft.
 BURN TIME: About 2.5 min.
 VELOCITY: 6,000 miles per hour at burnout (approx.)
 ALTITUDE AT BURNOUT: About 38 miles

MAJOR STRUCTURAL COMPONENTS

THRUST STRUCTURE
 FUEL TANK
 INTERTANK
 LOX TANK
 FORWARD SKIRT

MAJOR SYSTEMS

PROPULSION: Five bipropellant F-1 engines
 Total thrust: 7.5 million lb.
 Propellant: RP-1— 203,000 gal. or 1,359,000 lb.
 LOX—331,000 gal or 3,133,000 lb.
 Pressure: Control 1.27 cubic feet of gaseous nitrogen at 3,250 psig
 Fuel pressurization – 124 cubic feet or 636 lb. of gaseous helium at 3,100 psig
 LOX pressurization - gaseous oxygen converted from 6,340 pounds of LOX by the engines
 HYDRAULIC: Power primarily for engine start and for gimbaling four outboard engines
 ELECTRICAL: Two 28 VDC batteries, basic power for all electrical functions
 INSTRUMENTATION: Handles approx. 900 measurements
 TRACKING: ODOP Transponder



SATURN V NEWS REFERENCE

FIRST STAGE

FIRST STAGE DESCRIPTION

The Saturn V first stage (S-IC) is a vertical grouping of five cylindrical major components and a cluster of five F-1 rocket engines. Upward from the engines are the thrust structure, fuel tank, inter-tank structure, LOX tank, and forward skirt. The total stage measures 138 feet in height and 33 feet in diameter without its fins. It weighs 6,100,000 pounds at liftoff and delivers 7.5 million pounds of thrust.

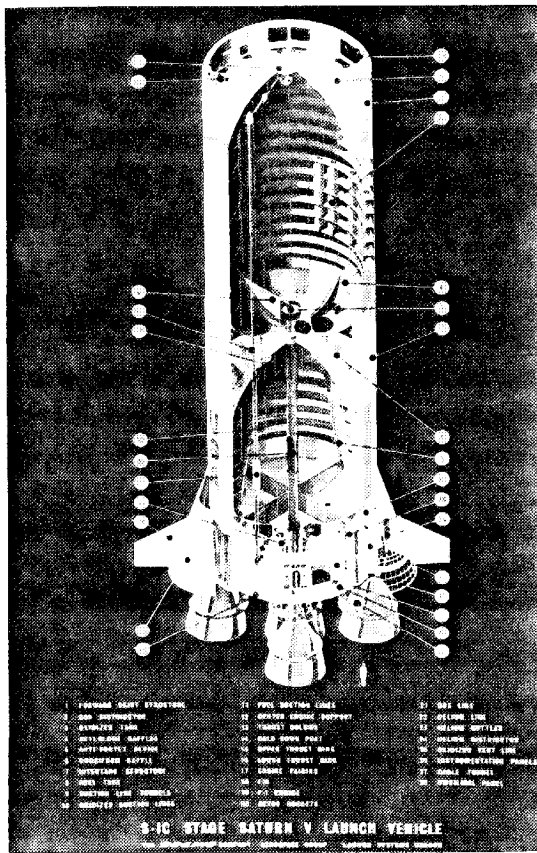

First Stage Cutaway

B-9454-1

FIRST STAGE FABRICATION AND ASSEMBLY

Design, assembly, and test of the first stage booster are the prime tasks being performed by The Boeing Company at the Marshall Space Flight Center, Huntsville, Ala., the Michoud Assembly Facility, New Orleans, La., and the Mississippi Test Facility in southwestern Mississippi. Launch operations support is provided by the Boeing Atlantic Test

Center, Kennedy Space Center, Fla. Contractor suppliers lend support for much of the first stage fabrication. Several ground test stages were completed before manufacture of a series of flight stages was begun. Huntsville and Michoud installations shared responsibility for assembly of four ground test stages and the first two flight stages. All other flight stages are being assembled at Michoud.

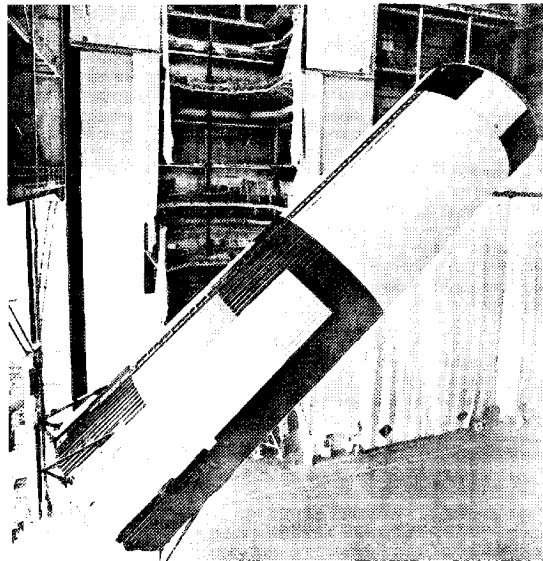

B-7031-10

Assembled First Stage

Thrust Structure

The thrust structure is the heaviest of first stage components, weighing 24 tons. It is 33 feet in diam-

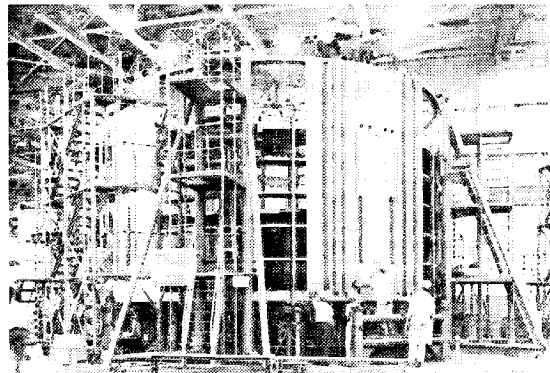

B-10648-5

Base Assembly—Workmen cover the thrust structure shell with aluminum skin.

SATURN V NEWS REFERENCE

eter and about 20 feet tall with these major components: the lower thrust ring assembly, the center engine support assembly, four holddown posts, engine thrust posts, an upper thrust ring assembly, intermediate rings, and skin panel assemblies.

The upper ring provides stability for the corrugated skins around the structure. Four F-1 engines are mounted circumferentially upon the thrust posts and the fifth upon the center engine support assembly. The center engine remains rigid while the others gimbal or swivel, allowing the stage to be guided.

A base heat shield protects internal parts from engine heat, and four holddown posts restrain the vehicle while the engines build up power for liftoff.

The thrust structure supports the entire vehicle weight and distributes the forces of the engines.

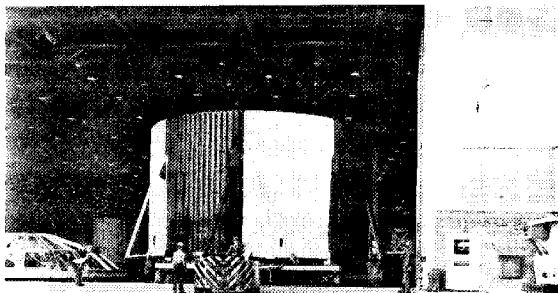

B-6018-7

Thrust Structure—The 24-ton base of the booster is being taken to the Vertical Assembly Building for mating with other first stage components.

Fuel Tank

The fuel tank holds 203,000 gallons of kerosene and encloses a system of five LOX tunnels.

The tank, weighing more than 12 tons dry, is capable of releasing 1,350 gallons of kerosene per second to the engines through 10 fuel-suction lines. The LOX tunnels carry liquid oxygen from the LOX tank, through the fuel tank, and to the engines.

Bound by eight aluminum skin panels, the fusion-welded fuel tank assembly is 33 feet in diameter and 44 feet tall. Ends are enclosed by ellipsoidal bulkheads.

The bulkheads consist of eight pie-shaped gores mated with a polar cap to form a dome shape.

Connecting links between the skin rings and bulkheads are circular bands known as the Y-rings. The Y-rings are used on both propellant tanks and link them to other segments of the booster at final assembly.

2-2

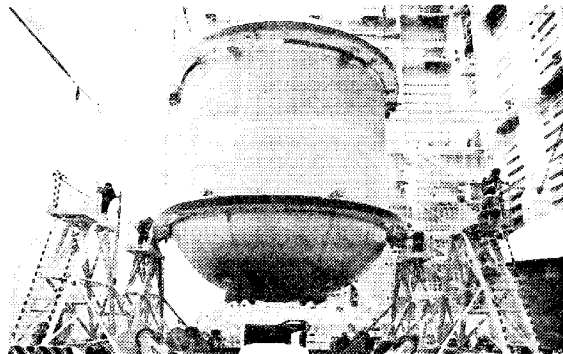

B-6469-20

Fuel Tank—Kerosene is fed to the engines at 1,300 gallons per second from this 203,000 gallon tank. Here the finished tank is being lowered onto its transporter.

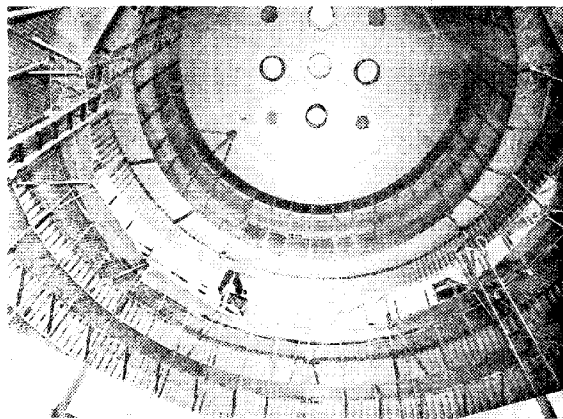

B-5622-4

Inside View—The fuel tank contains horizontal baffles, which are designed to prevent sloshing of fuel.

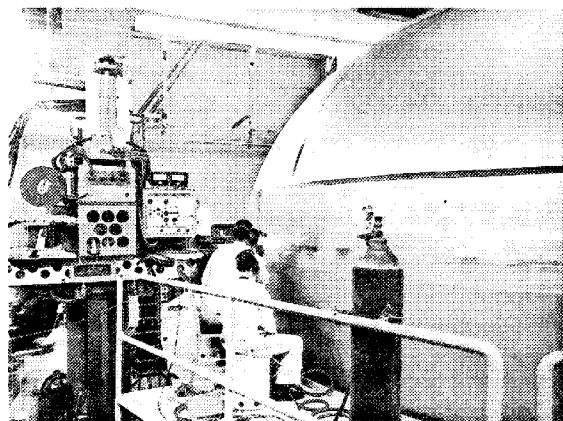

B-4780-6

Fuel Tank Assembly—Workmen weld the base of the 27-inch-high Y-ring to the cylindrical segment of the fuel tank. This ring joins the tank sides to the dome and to the intertank structure.

SATURN V NEWS REFERENCE

LOX Tank

The 331,000-gallon liquid oxygen tank is the largest component of the first stage booster, standing more than 64 feet in height. Its content is 297 degrees below zero Fahrenheit and provides the oxidizer to support combustion of the kerosene. Mixing of the two propellants is in a proportion to ensure complete combustion. Each second during flight, the engines consume more than 2,000 gallons of liquid oxygen.

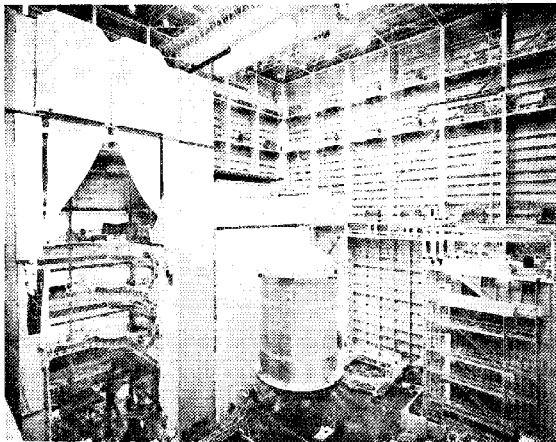

B-8219-3

LOX Tank—The completed 331,000-gallon LOX tank is being carried to the hydrostatic testing facility where it will be tested for leaks.

The LOX tank's construction is similar to that of the fuel tank with the LOX tunnels beginning at the tank base, running through the intertank and fuel tank and to the engines. Dry weight of the LOX tank exceeds 19 tons.

Intertank

The intertank is not a tank in itself but serves as a 6-1/2-ton link between fuel and LOX tanks. Its composition is 18 corrugated skin panels supported by five frame ring assemblies.

The lower bulkhead of the LOX tank dips into the intertank while the upper bulkhead of the fuel tank extends upward into the intertank. Around the edges of the intertank are attached 216 fittings, which fasten the tank together with the Y-rings of the fuel and LOX tanks. The intertank structure also contains a personnel access door.

Umbilical Openings

An umbilical opening in the intertank provides for electrical and instrumentation requirements, emergency LOX drain, line pressurization, electrical conduit, and provisions for venting internal pressure. The thrust structure contains three of four other umbilical openings on the booster. The fourth is located in the forward skirt. The thrust structure umbilicals carry the fuel line, liquid oxygen drain, ground supply fluid lines, and all control functions essential in case of a vehicle abort.

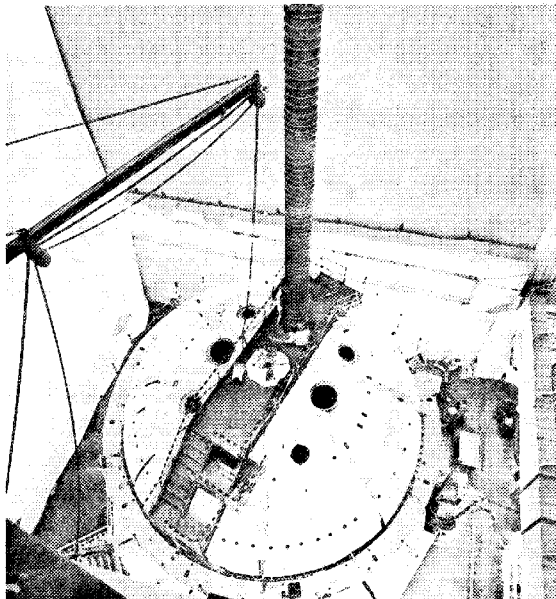

B-5773-6

LOX Tunnel—Five 42-foot tunnels bring liquid oxygen from the LOX tank through the fuel tank and to the engines. Here a tunnel is being fitted into the fuel tank.

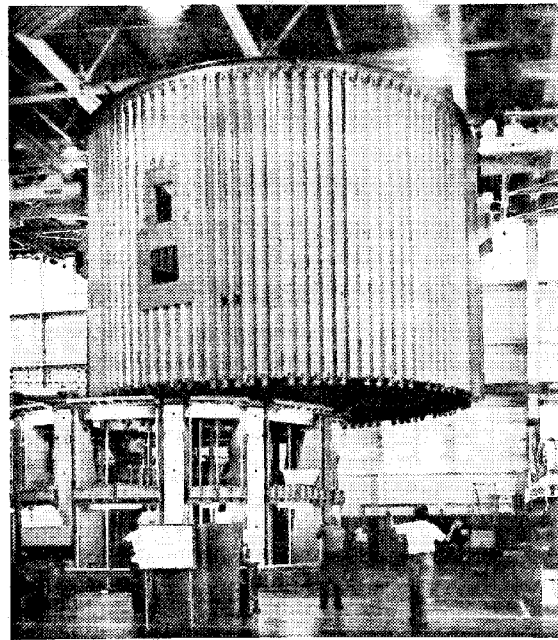

B-3291-6

A Completed Intertank

SATURN V NEWS REFERENCE

Forward Skirt

The forward skirt tops the first stage and provides a connecting link for the first and second stages of the Saturn V.

Weighing 2-1/2 tons, the structure consists of 12 skin panels attached to three circumferential support rings. It contains a small personnel access door; an umbilical opening for telemetry cables, an environmental air duct, and minor pneumatic lines; and an umbilical disconnect door.

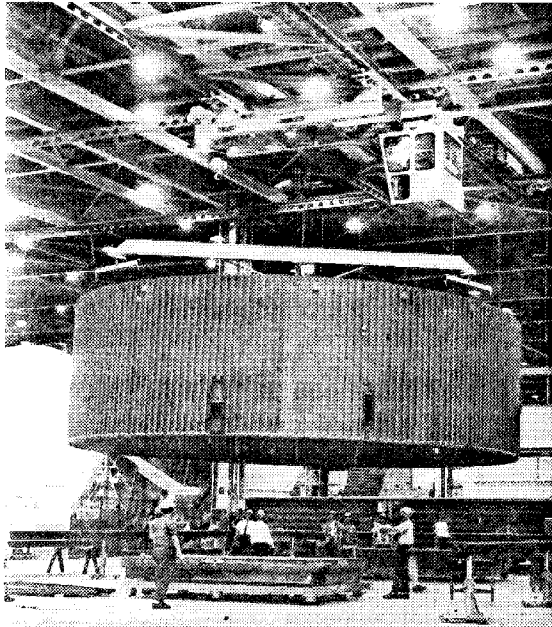

B-2835-34

Forward Skirt—The structural link between the LOX tank and the engine shroud of the second stage is shown being lowered for dimensional inspection.

Fins and Fairings

Four fairings attach to the thrust structure and partially surround the outboard engines at the foot of the booster. They house the eight retrorockets and the actuator support structures. Fairings are shaped like cone halves and are constructed of aluminum. Their purpose is to smooth the air flow over the engines.

The fins are airfoil attachments to the fairings. Fins are rigid and add to the vehicle's flight stability. A titanium skin covers the fin for greatest protection against temperatures as high as 2,000 degrees Fahrenheit.

Each of the eight retrorockets generates about 86,600 pounds of thrust for two-thirds of a second

and, upon firing, blows off the tips of the fairings. (Retrorocket thrust varies with propellant temperature.)

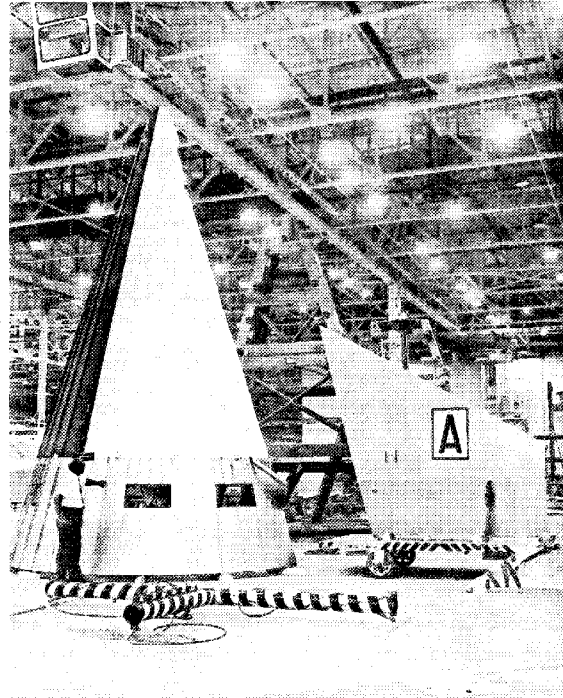

B-6733-3

Fin and Fairing Assembly—Fairings are fitted over each of the outboard engines to smooth the air flow. Fins are attached to the fairings.

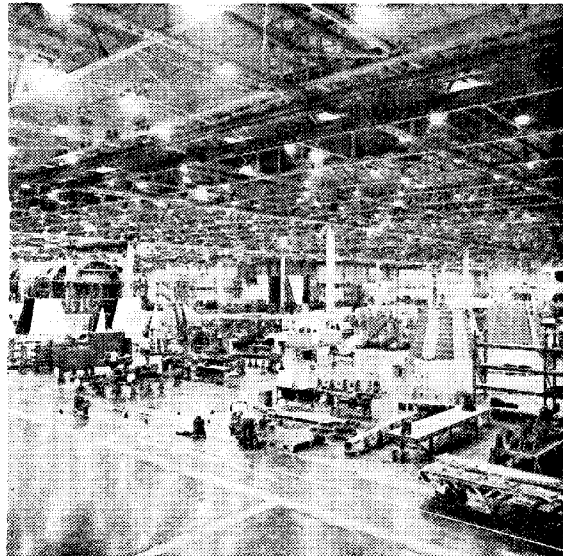

B-9580-8

Michoud Manufacturing Area—In the foreground of this Michoud plant view, fairings are being assembled.

SATURN V NEWS REFERENCE

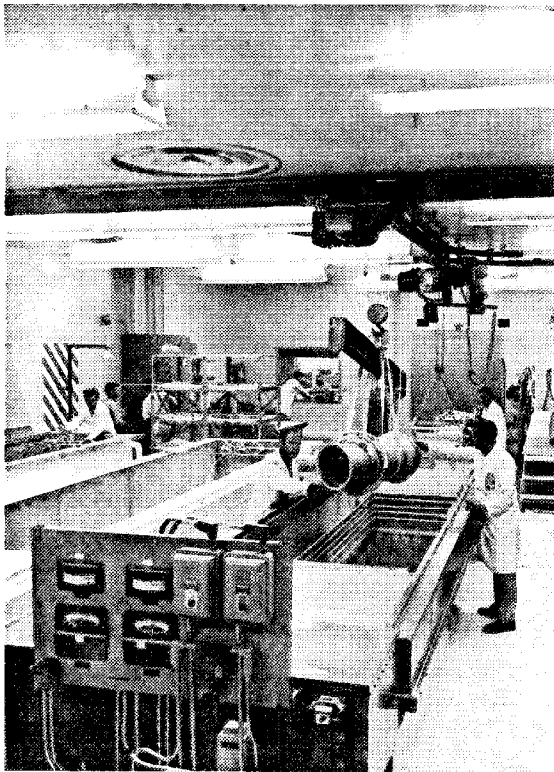

B-9940-7

Tube and Valve Cleaning Vat—Each stage component is treated in a cleaning solution before final assembly.

Vertical Assembly

When all major components of the first stage are assembled in NASA's Michoud Assembly Facility, they are routed to the Vertical Assembly Building to be assembled.

Manipulated by an overhead crane, the components are placed in final assembly position in the single-story building rising the equivalent of 18 stories.

First the thrust structure is placed on four heavy pylons 20 feet above floor level. Meanwhile, two of the segments—the fuel and LOX tanks which are brought to the Vertical Assembly Building in segments—are being completed on two tank assembly bays. Then, in building-block fashion, the thrust structure is joined by the fuel tank, intertank, LOX tank, and forward skirt. When the forward skirt is secured, the first stage stands 138 feet high.

Vertical assembly completed, the 180-ton-capacity overhead crane lifts the booster by a forward handling ring attached to the forward skirt and returns it to horizontal position on its 435,000-pound transporter.

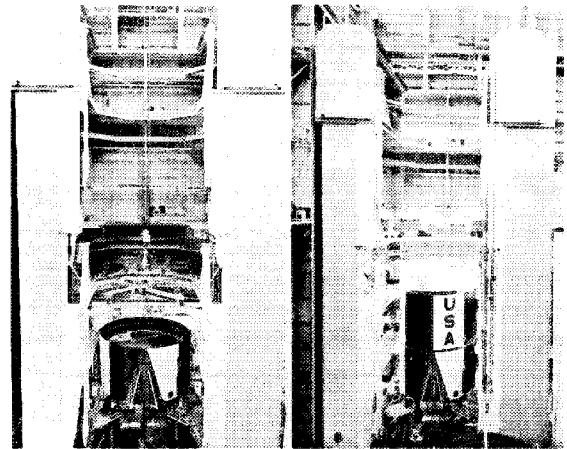

B-7241-2

B-8565-2

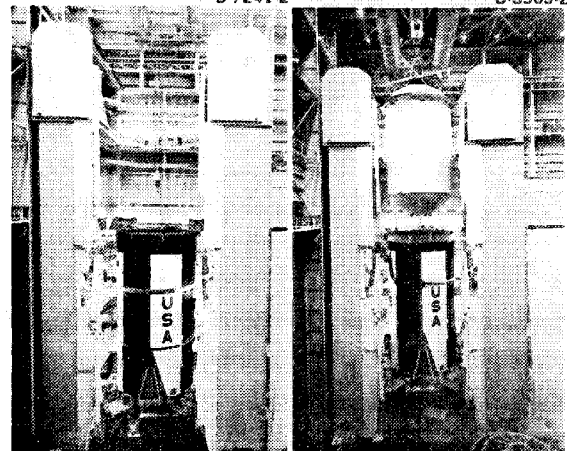

B-8565-5

B-7594-6

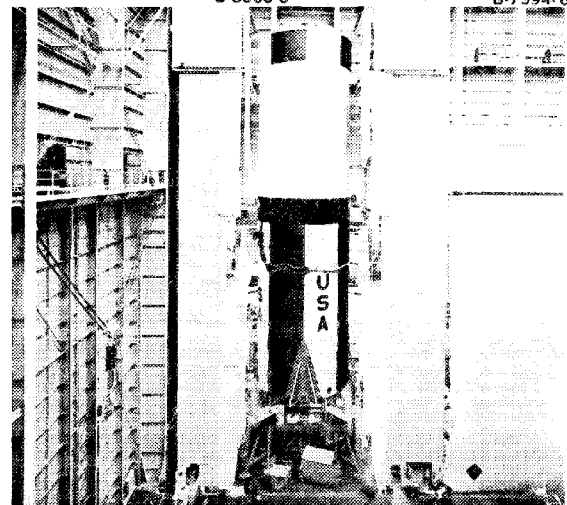

B-7594-1

Vertical Assembly—Booster sections are mated in the Vertical Assembly Building. At top left the thrust structure is shown. Fuel tank, intertank assembly, LOX tank, and forward skirt are added in successive pictures.

SATURN V NEWS REFERENCE

As assembly jobs approach completion, installation of internal systems and engines is made in preparation for systems test and checkout.

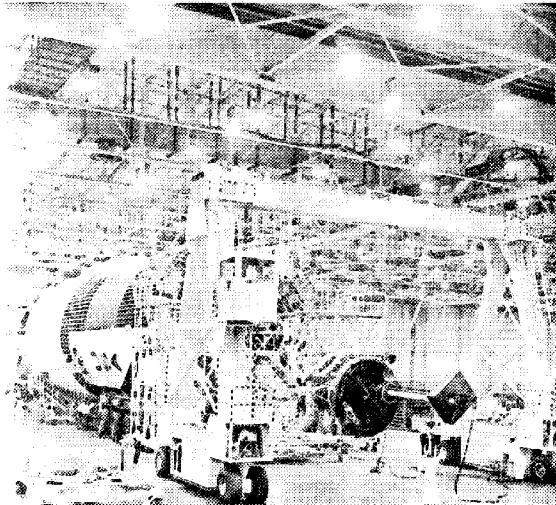

B-10872-4

Engines—One of the first stage's F-1 engines is mounted. Together the five will consume 4,492,000 pounds of propellants in 2.5 minutes.

POST MANUFACTURING CHECKOUT

Before a booster leaves Michoud for test firing, its electrical and mechanical systems are tested extensively by Boeing technicians and engineers. The Stage Test Building with four giant test cells provides the facility. Inside the building are four control rooms, four computer rooms, and two telemetry rooms. These rooms house equipment that demonstrates the acceptability of the integrated systems of the booster. This includes telemetry calibration, continuity checks, and discrete-function monitoring. RF (radio frequency) also is evaluated.

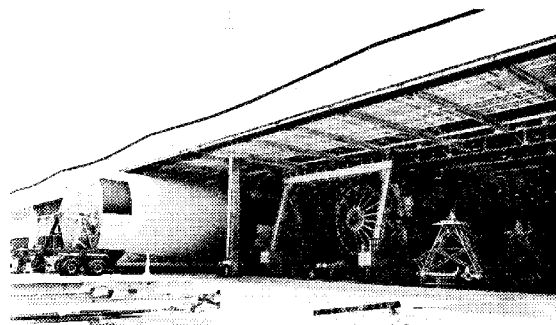

B-7733-10

Moving—A completed first stage is readied for post-manufacturing checkout.

Mechanical, hydraulic, and pneumatic systems tests are conducted to leak-check and functionally check the propellant systems and the engine complex. Checks then are performed to demonstrate the proper operation of the electrical and instrumentation systems. All systems are operated and checked individually and then checked as an integrated system in the automatic all-systems checkout.

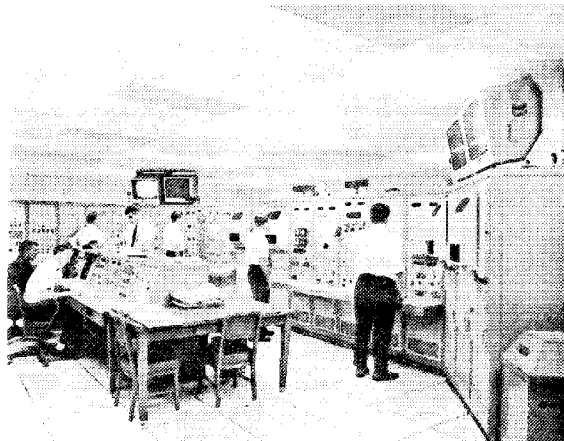

B-9964-2

Monitoring—Technicians check booster performance during a simulated flight from a stage test control room.

After the operation of the test and checkout equipment is verified, all electrical, pneumatic, and hydraulic connections are made to the stage, resistance checks are run, and the stage undergoes physical examination.

The environmental control system is connected and checked for proper operation, and the stage's electrical circuits are physically checked for resistance. Stage electrical power is applied in sequential steps and the distribution monitored. The stage instrumentation transmission system is checked out on both coaxial hardwire and RF links. The electrical systems checkout includes checks of the power distribution circuits, heater power subsystems, destruct system, sequencing subsystem, separation subsystem, and emergency detection system.

The range safety systems undergo a complete end-to-end checkout including transmittal of RF commands to the range safety command receiver and monitoring the arm, cutoff, and destruct signals generated by the system.

Instrumentation system testing during stage checkout includes: identification of data channels, gain adjustment of signal conditioners, and checks of measurement systems, telemetry systems, and operational RF systems.

SATURN V NEWS REFERENCE

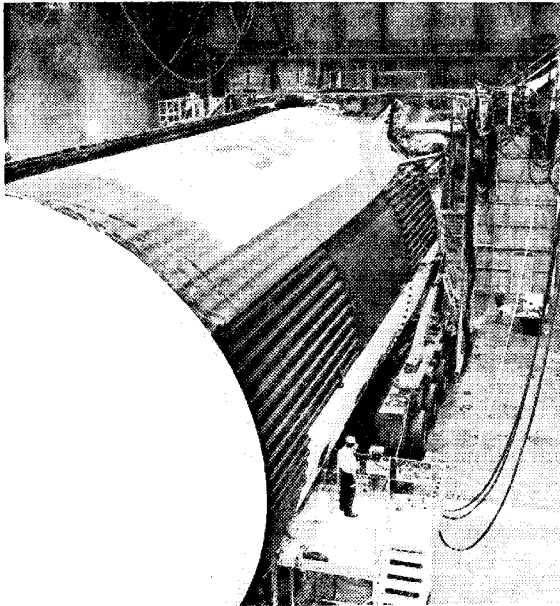

B-9908-1

First Stage in Test Cell

Pressure and leak checks are conducted on fuel and LOX tanks and associated lines, engines, fuel and LOX delivery systems, fuel and LOX pressurization systems, and the control pressure system. Checks are made of the calibration pressure switch simulation, fill and drain operation, and prevalve operation on both fuel and LOX systems.

Propulsion system checks include checks of firing command preparation and execution, engine shutdown prior to "launch commit," malfunction cutoff, and normal propulsion sequences.

Most of the above-mentioned tests are run for a second time prior to static testing and again during post-static checkout.

FIRST STAGE SYSTEMS

Fuel System

The first stage fuel system supplies RP-1 fuel to the F-1 engines. The system consists of a fuel tank, fuel feed lines, pressurization system, fill and drain components, fuel conditioning system, and associated hardware to meet the propulsion system requirements.

FUEL TANK

The fuel tank, previously described, holds 203,000 gallons of kerosene and is capable of providing 1,350 gallons of fuel per second to the engines through 10 fuel-suction lines.

FUEL FILL AND DRAIN SYSTEM

The fuel tank is filled through a 6-inch duct at the bottom of the tank. Fill rate is 200 gallons per minute until the tank is 10 per cent full. After reaching the 10 per cent mark, filling is increased to 2,000 gallons per minute until the tank is full. Normal nonemergency drain takes place through the same duct. A ball-type valve in the fill and drain line provides fuel shutoff.

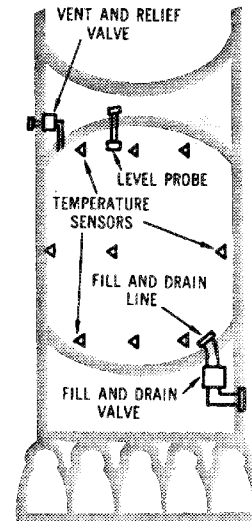

Fuel Fill and Drain

The fuel fill and drain system consists of a fill and drain line, a fill and drain valve, a fuel loading level probe, and nine temperature sensors. During fuel fill, the temperature sensors provide continuous fuel temperature information used to compute fuel density. When the fuel level in the fuel tank rises to about 102 per cent of flight requirements, the fuel loading probe indicates an overload.

After adjusting fuel to meet requirements, the fill and drain valve is closed.

The fuel tank can be drained under pressure by closing the fuel tank vent and relief valve, supplying a pressurizing gas to the tank through the fuel tank prepressurization system, and opening the fuel fill and drain valve.

FUEL FEED SYSTEM

Ten fuel suction lines (two per engine) supply fuel from the fuel tank to the five F-1 engines. The suction line outlets attach directly to the F-1 engine fuel pump inlets.

Each suction line has a pneumatically controlled fuel prevalve which normally remains open. This

SATURN V NEWS REFERENCE

prevalve serves as an emergency backup to the main engine fuel shutoff valves to terminate fuel flow to the engines.

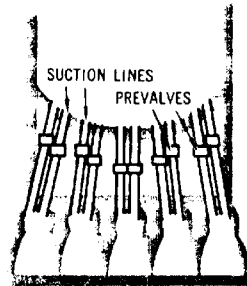

Fuel Feed

FUEL-CONDITIONING (BUBBLING) SYSTEM

The fuel-conditioning system bubbles gaseous nitrogen through the fuel feed lines and fuel tank to prevent fuel temperature stratification prior to launch. A wire mesh filter in the nitrogen supply line prevents discharge of contaminants into the conditioning system.

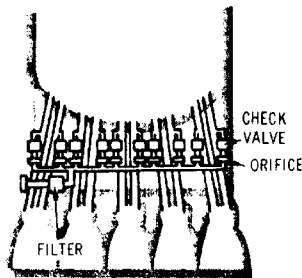

Fuel Conditioning

A check valve in the outlet of each fuel-conditioning line prevents fuel from entering the nitrogen lines when the fuel-conditioning system is not operating.

An orifice located near each fuel-conditioning check valve provides the proper nitrogen flow into each fuel duct.

FUEL LEVEL SENSING AND ENGINE CUTOFF SYSTEMS

A cutoff sensor mounted on the bottom of the fuel tank provides signal voltages to shut off fuel after a predetermined level of depletion is reached. The fuel is measured during flight by four fuel slosh probes and a single liquid level measuring probe. Fuel levels are detected electronically and reported through the stage telemetry system. Telemetry

signals are transmitted to ground support either by radio frequency or, before launch, by coaxial cable. The cutoff sensor, mounted in the lower fuel tank bulkhead, initiates engine cutoff as fuel level falls below two sensing points on the probe. Engine cutoff will normally be initiated by sensors in the LOX system. The cutoff capability is provided as a backup system should fuel be depleted before LOX.

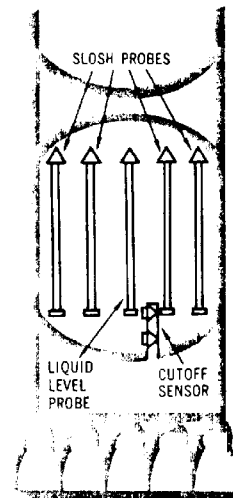

Fuel Level Sensing and Engine Cutoff

FUEL PRESSURIZATION SYSTEM

The fuel pressurization system maintains enough pressure in the fuel tank to provide proper suction at the fuel turbopumps to start and operate engines. The system consists of a helium supply, a helium flow controller, helium fill and drain components, a prepressurization subsystem, a fuel tank vent and relief valve, and associated ducts.

Four 31-cubic-foot, high pressure storage bottles in the LOX tank store the helium required for in-flight pressurization of the fuel tank ullage. A high pressure line is used for filling the bottles and routing the helium to the flow controller. A solenoid dump valve is installed for emergencies. The helium flow controller uses five solenoid valves mounted parallel in a manifold to control helium flow to the fuel tank ullage. The cold helium duct routes helium from the flow controller to the cold helium manifold. From there, it is distributed to the heat exchangers on the five F-1 engines. The hot helium manifold receives the heated, expanded helium from the engine heat exchangers and routes it to the hot helium duct which then carries it through the helium distributor and on to the fuel tank ullage.

SATURN V NEWS REFERENCE

Three absolute pressure switches, mounted atop the fuel tank, monitor and control fuel tank pre-pressurization before engine ignition, fuel tank pre-pressurization during flight, and overpressure.

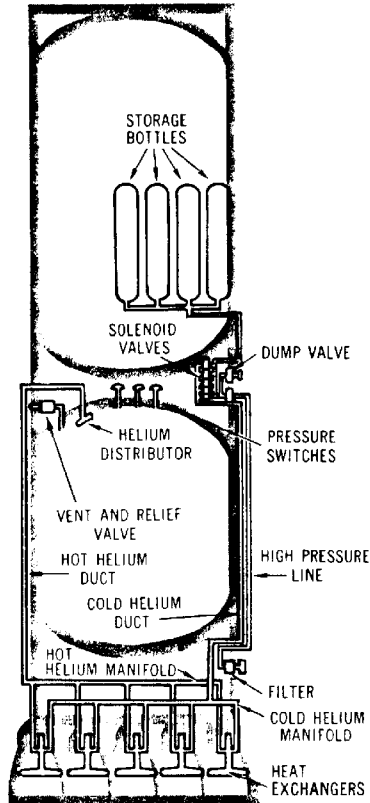

Fuel Pressurization

Design strength of the four helium bottles at atmospheric temperatures and prior to LOX loading is about 1,660 pounds per square inch gage (psig). After LOX loading, when the bottles are cold, pressure is increased to about 3,100 psig.

A filter in the helium fill line prevents contaminants from entering the flight pressurization system.

LOX System

The liquid oxygen (LOX) system supplies LOX to the five F-1 engines. The system consists of a LOX tank, fill and drain components, LOX suction lines, pressurization subsystem, and associated hardware.

LOX TANK

In addition to the components of the LOX tank previously described, the tank contains internal ring baffles which line the tank walls to provide

wall support and prevent excessive sloshing of LOX. A cruciform baffle in the lower tank head limits LOX swirling. Four LOX liquid level probes continuously monitor LOX level in the tank. The probes are made up of a series of continuous capacitive level sensors separated by discrete level sensors.

LOX FILL AND DRAIN SYSTEM

LOX is forced under pressure through two 6-inch LOX fill and drain lines into the tank at a slow fill rate of 1,500 gallons per minute until the tank is 6.5 per cent full. The slow fill rate avoids splash damage to LOX tank components. After a visual leak check, a fill rate of 10,000 gallons per minute takes place until the tank is 95 per cent full. After this, the rate is reduced to 1,500 gallons per minute until the LOX loading level probe senses a full tank and terminates LOX fill. In addition to the two 6-inch lines used for LOX fill and drain, a third line is available for filling the tank through the inboard suction line.

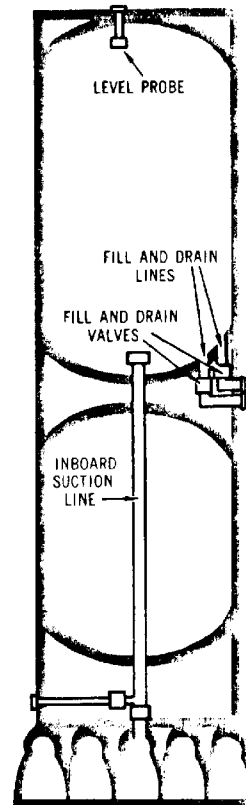

LOX Fill and Drain

LOX boils continuously to maintain the temperature of -297 degrees Fahrenheit at sea level pressure.

SATURN V NEWS REFERENCE

It is replenished between the periods of loading and prepressurization through the fill and drain line.

Before LOX drain can be performed, the helium cylinders in the LOX tank must have their pressure decreased from about 3,100 psig to about 1,660 psig. Fill and drain valves are opened to complete drainage of the LOX tank although total evacuation of LOX from the tank requires draining the engines or waiting for boil-off of residual LOX. LOX drain can be speeded with the aid of a pressurizing gas, usually nitrogen.

LOX DELIVERY SYSTEM

LOX is delivered to the engines by five 17-inch suction lines which pass through the fuel tank in five LOX tunnels. LOX suction ducts make up the lines from the LOX tank to the prevalues in the thrust structure. The ducts are equipped with gimbals and sliding joints to counteract vibration and swelling or contraction caused by temperature. Inside the tunnels, air acts as the insulation between the LOX-wetted lines and the fuel-wetted tunnels.

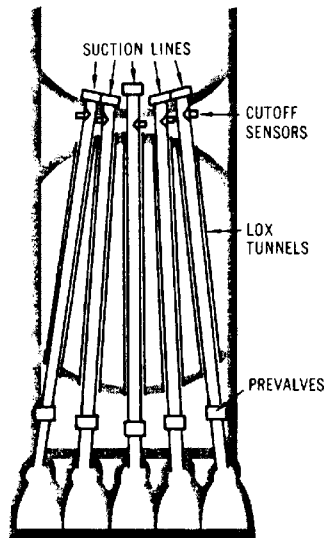

LOX Delivery

LOX level engine cutoff sensors in the suction lines assure safe engine shutdown and leave a minimum amount of unused LOX in the system.

In case of emergency, LOX prevalues in each suction line can stop the flow of LOX to the engines.

LOX CONDITIONING SYSTEM

LOX cannot exceed -297 degrees Fahrenheit or

it will result in gaseous oxygen (GOX). If heat is increased, the result is boiling and not temperature increase since evaporation is a cooling process. Depth in a body of LOX can increase due to the increase in hydrostatic pressure.

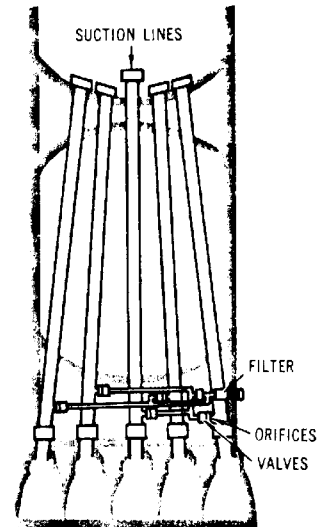

LOX Conditioning

The greatest chance for overheating in the LOX system is in the transmission surface of the suction lines. Also, the suction lines are too slender for maintenance of self-contained convection currents. This situation is unacceptable since intense boiling can lead to LOX geysering, which in turn can damage the LOX tank structurally. In addition, too high a LOX temperature near the engine inlets can cause a cavity in the LOX pumps and interfere with normal engine starting. Emergency bubbling or thermal pumping is used to correct this situation.

The bubbling technique sends helium into all five suction lines to cool the LOX rapidly. Ground support supplies helium through an umbilical coupling, and filter valves and orifices control the flow of helium into the suction lines. Thermal pumping is a term used to define pumping relatively cold LOX from the LOX tank into the suction lines.

LOX PRESSURIZATION SYSTEM

Pressurizing gases used in the LOX tank are helium, gaseous oxygen, and nitrogen. These gases are used in prepressurization, flight pressurization, and storage pressurization.

Prepressurization is necessary 45 seconds prior to

SATURN V NEWS REFERENCE

engine ignition to give sufficient tank ullage pressure for engine start and thrust buildup. Helium, used as the pressurizing gas to reduce flight weight, is supplied by ground support through the helium ground connection. It proceeds up the gaseous oxygen line into the LOX tank through the GOX distributor. The flow of helium is monitored by the pressure duct and stopped at 26 pounds per square inch absolute (psia) maximum and is resumed when the pressure drops to 24.2 psia during engine start. Ground-supplied helium is available until liftoff. GOX is added to the LOX tank for pressurization during flight. Each engine contributes to GOX pressurization. A portion of LOX—6,340 pounds—passing through the engine is diverted from the LOX dome into the engine heat exchanger where hot gases exhausted from each engine turbine transform LOX into GOX. The GOX flows from each heat exchanger into the GOX line manifold through the flow control valve, up the GOX line, and into the LOX tank through the GOX distributor. The GOX flow is approximately 40 pounds per second to maintain a LOX tank ullage pressure of 18 to 23 psia.

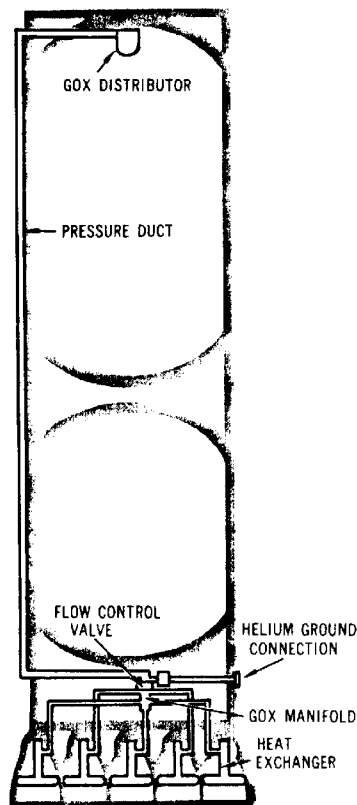

LOX Pressurization

While the booster is being stored or transferred from one location to another, a slight positive nitrogen pressure is maintained for cleanliness and low humidity conditions. The external nitrogen pressure source is removed during flight operations.

Fluid Power System

An unusual but convenient type of fluid power or hydraulic system is in use on the Saturn V first stage. It incorporates the same types of fuels—RP-1 and RJ-1 (kerosene)—that are used in the stage fuel system. Ordinarily a different and weaker type of fluid is used for hydraulics. This system eliminates the use of a separate pumping system.

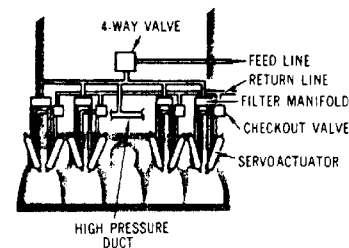

Fluid Power System

The fluid power system provides ground and flight fluid power for valve actuation and thrust vectoring. It gives power primarily to the engine start system and the engine gimbaling system. Its source is the fuel system. RJ-1 is provided from the ground before liftoff, and RP-1 is supplied from the fuel tank during flight.

The ground supply of RJ-1 is routed to all five engines at 1,500 psig and eventually back to the ground supply. After ignition, RP-1 is routed from the high pressure fuel duct to the servoactuators for hydraulic power to position the engines.

The center engine, which has no thrust vectoring system, directs its hydraulic fluid through the feed line and 4-way hydraulic control valve to supply pressure to the closing ports of the gas generator, main fuel valves, and main LOX valves. The fuel passes through orifices and then is ducted through the ground checkout valve and back to ground supply through the return line.

The four outboard engines direct RJ-1 through the servoactuators to the ground checkout valve where it is returned through a coupling to ground supply.

Electrical System

The electrical power and distribution system of the

SATURN V NEWS REFERENCE

first stage provides power for controlling and measuring functions of the vehicle. The system operates during static firing, launch preparation and checkout, launch, and flight.

The electrical system consists of two batteries, a main power distributor, a sequence and control distributor, propulsion distributor, timer distributor, measuring distributors, thrust OK distributor, and measuring power distributor.

Two independent 28-volt DC power systems are installed on the stage. System No. 1, the main power battery, energizes the stage controls. The battery has a 640-ampere-minute rating, weighs about 22 pounds, and is used to control various solenoids. Battery No. 2, the instrumentation battery, energizes the flight measurement system and gives power to redundant systems for greater mission reliability. It has a 1,250-ampere-minute rating and weighs approximately 55 pounds. The range safety system can be operated by either battery.

Preflight power is supplied from ground equipment through umbilical connections. The supply for each system is 28 volts. Ground sources supply power for heaters, ignitors, and valve operators that are not operated during flight.

The distributors subdivide the electrical circuits and serve as junction boxes. Both electrical systems share the same distributors. The main power distributor houses relays, the power transfer switch, and electrical distribution buses. The relays control circuits that must be time-programmed. The motor-operated, multi-contact, power transfer switch transfers the stage load from the ground supply to the stage batteries. The transfer is tried several times during countdown to verify operation. Power is distributed by the main buses.

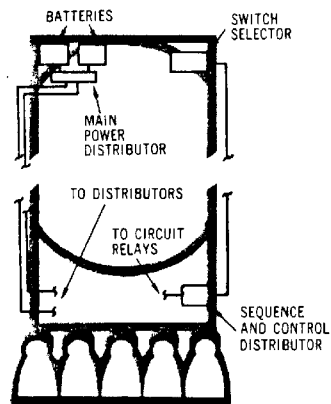

Electrical System

The switch selector, actuated by the instrument unit (IU), commands the sequence and control distributor, which in turn amplifies the signals received. The sequence and control distributor then energizes the various circuit relays required to implement the flight program. The switch selector is an assembly of redundant low power relays and transistor switches, which control the sequence and control distributor. It is activated by a coded signal from the instrument unit computer.

The propulsion distributor contains the monitor and control circuits for the propulsion system.

The thrust OK distributor contains the circuits that shut down the engines when developed thrust is inadequate. Two of the three thrust OK switches must operate or the engine will be shut down.

The timer distributor houses the circuits to delay the operation of relay valves and other electro-mechanical devices. The programmed delays are essential for optimum performance and safety.

The measuring power distributor contains electrical buses, and the measuring distributors route data from measuring racks, serve as measurement signal junction boxes, and switch data between the hardware and telemetry.

Instrumentation System

The first stage instrumentation system measures and reports information on stage systems and components and provides data on internal and external environments. It keeps abreast of approximately 900 measurements on the stage, such as measurements of valve positions, propellant levels, temperatures, voltages, and pressures. The measurements are telemetered by coaxial cable to ground support equipment and by radio frequency transmission to ground stations.

The instrumentation system consists of a measurement system, a telemetry system, and the Offset Doppler tracking system. A remote automatic calibration system provides remote rapid checkout of the measurements and telemetry systems.

MEASUREMENT

The measurement system reports environmental situations and how the first stage reacts to them. Making use of transducers, signal conditioners, measuring rack assemblies, measuring distributors, and the onboard portion of the remote automatic calibration system, this system involves many phases of stage operation. Included are measurements of acceleration, acoustics, current, flow, flight

SATURN V NEWS REFERENCE

angles, valve position, pressure, RPM's, stress, temperature, vibration, and separation.

TELEMETRY

Telemetry is a method of remote monitoring of flight information accomplished by means of a radio link. The first stage telemetry system is composed of six radio frequency links.

Most of the components of the telemetry systems are located in the thrust structure; RF assemblies and a tape recorder are located in the forward skirt. The telemeter transmits data through two common antenna systems.

Links F1, F2, and F3 are identical systems which transmit narrow-band, frequency-type data such as that generated by strain gages, temperature gages, and pressure gages. The system can handle 234 measurements on a time-sharing basis and 14 measurements transmitted continuously. Data may be sampled either 120 times per second or 12 times per second.

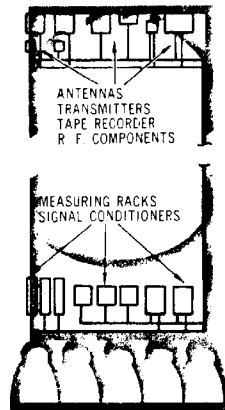

Telemetry

Links S1 and S2 transmit wide-band, frequency-type data generated by vibration sensors. Each link provides 15 continuous channels or a maximum of 75 multiplexed channels depending on the specific measuring program.

Telemeter P1 transmits either pulse code modulated or digital type data. Five multiplexers, four analogs, and one digital supply data to the PCM assembly. This provides the most accurate data and is used for ground checkout as well.

A telemetering calibrator is used to improve the accuracy of the telemetry systems. The calibrator supplies known voltages to the telemeters periodically during the stage operation.

Their reception at tracking stations provides a valid reference for data reduction.

The effects of ullage and retrorocket firing attenuation can seriously degrade the telemetry transmission during stage separation; therefore, a tape recorder installed in the forward skirt records data for delayed transmission. The commands for tape recorder operation originate in the digital computer located in the instrument unit.

ODOP SYSTEM (Offset Doppler Tracking System)

The ODOP system is an elliptical tracking system that measures the rate of motion at which the vehicle is moving away from or toward a tracking station. The total Doppler shift in the frequency of a continuous wave, ultra-high frequency signal transmitted from the ground to the first stage is measured. The signal is received by the transponder at the stage, modified, and then retransmitted back to the ground. Retransmitted signals are received simultaneously by three tracking stations. Separate antennas on the stage are used for receiving and retransmitting the signals.

SEPARATION SYSTEM

A redundant initiation system actuates the separation of the first stage from the second stage. A command signal for arming and another for firing the initiation systems are programmed by the instrument unit computer.

After LOX depletion, the computer signals operate relays in the switch selector and sequence and control distributor to control the exploding bridgewire firing units. When armed, the firing units store a high voltage electrical charge. When fired, the electrical charge actuates the ordnance.

Two firing units are installed on the first stage for the eight retrorockets, and two are installed on the second stage for the separation ordnance.

Range Safety System

The function of the range safety system is to provide ground command with the capability of flight termination by shutting off the engines, blowing open the stage propellant tanks, and dispersing the fuel in event of a flight malfunction.

The system is redundant, consisting of two identical, independent systems, each made up of electronic and ordnance subsystems.

SATURN V NEWS REFERENCE

Flight termination by way of the range safety system goes into effect upon receipt of the proper radio frequency commands from the ground. A frequency-modulated RF signal transmitted from the ground range safety transmitter is received by the antennas and transmitted by way of a hybrid ring to the range safety command receiver. There, the signal is conditioned, demodulated, and decoded.

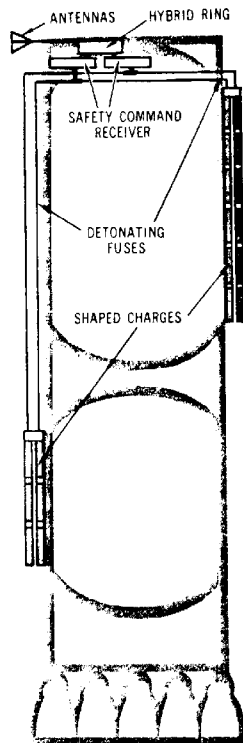

Range Safety System

The resulting signal simultaneously causes arming of the exploding bridgewire firing unit and shutdown of the stage engines. A second command signal transmitted by the ground range safety transmitter ignites the explosive train (detonating fuses and shaped charges) to blow open the stage propellant tanks.

Control Pressure System

The control pressure system supplies pressurized gaseous nitrogen for the pneumatic actuation of propellant system valves and purging of various F-1 engine systems.

The complete integrated system is made up of an onboard control pressure system, a ground control

pressure system, and an onboard purge pressure system. The object in each system is to deliver an actuating or purge medium to an interfacing stage system.

ONBOARD CONTROL PRESSURE SYSTEM

The onboard control pressure system consists of a high-pressure nitrogen storage bottle, an umbilical coupling and tubing assembly for filling the storage bottle, a manifold assembly, and control valves at the terminal ends of various nitrogen distribution lines. In some cases, two valves are paired with other associated equipment and block-mounted to form a control assembly.

The nitrogen onboard storage bottle has 2,200-cubic inch capacity and is made of titanium alloy. It is designed for a maximum proof pressure of 5,000 psig. It is filled and discharged through a port in the single boss. During flight launch preparation, the bottle is filled from a ground supply first to a pressurization of 1,600 psig well in advance of final countdown. This weight pressure is adequate for any prelaunch operational use. The second step occurs in the last hour of the launch countdown and

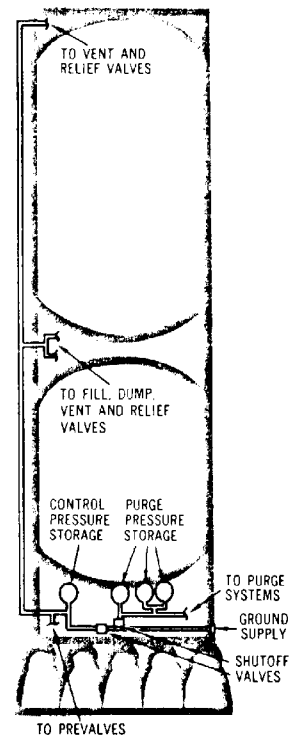

Control Pressure System

SATURN V NEWS REFERENCE

brings the storage bottle pressure up to its normal capacity of 3,250 plus or minus 50 psig.

The manifold assembly serves as a gaseous nitrogen central receiving and distributing center as well as a mounting block for filters, shutoff solenoid valves, a pressure regulator, a relief valve, and pressure transducers. Ported manifolds provide tubing assembly connections to the storage bottle, umbilical coupling, and various tubing assembly distribution lines to control valves throughout the stage.

GROUND CONTROL PRESSURE SYSTEM

The ground control pressure system provides a direct ground pressure supply for some of the first stage pneumatically actuated valves. The valves are involved with propellant fill and drain and emergency engine shutdown system operations. Direct ground control assures a backup system in case of emergency and conserves the onboard nitrogen supply.

ONBOARD PURGE PRESSURE SYSTEM

The onboard purge pressure system consists of three high-pressure nitrogen storage bottles identical to the onboard control pressure storage bottle, an umbilical coupling and tubing for filling the bottles, and a manifold assembly and tubing for receiving and delivering the gas to the engine and calorimeter purge systems. These purge systems expel propellant leakage and are necessary from the time of loading throughout flight.

Environmental Control System

The environmental control system protects stage equipment from temperature extremes in both the forward skirt and thrust structure areas and provides a nitrogen purge during prefiring and firing operations.

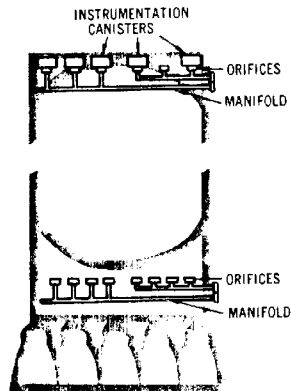

Environmental Control System

Temperature-controlled air is provided by a ground air conditioning unit from approximately 14 hours before launch to approximately 6 hours before launch. At this time, gaseous nitrogen from an auxiliary nitrogen supply unit is introduced into the system and used to purge and condition the forward skirt and thrust structure areas until umbilical disconnect at launch.

A distribution manifold vents air and gaseous nitrogen through orifices into the thrust structure to maintain proper temperature. Air and nitrogen are supplied from the ground.

The system also distributes air and gaseous nitrogen to instrumentation canisters mounted in the forward skirt. Temperatures in the canisters are held to meet requirements of electrical equipment. From the canisters, the conditioning gas is vented into the forward skirt compartment.

Visual Instrumentation

Visual instrumentation, presently planned to be installed on two flight stages, is designed to monitor critical stage functions prior to and during static test and flight conditions.

FILM CAMERAS

The first stage film cameras provide photographic coverage of the LOX tank interior during launch, flight, and separation. The stage carries four film cameras. The two LOX-viewing cameras will provide color motion pictures to show the following: behavior of the liquid oxygen, possible wave or slosh motions, and cascading or waterfall effects of the liquid from the internal tank structure. The capsules, which contain the cameras, are ejected automatically about 25 seconds after separation and are recovered after descent into the water. First stage film versions of the camera consist of the LOX tank-viewing configuration plus two direct-viewing stage separation capsules. The installation is in the forward skirt area. The tank-viewing optical lenses and the two strobe flash light assemblies are mounted in the LOX tank manhole covers. Connecting the remotely located camera capsules and the flash head are the optical assemblies, consisting of coupling lens attached to the ejection tube, a 9-foot length of fiber optics, and the objective lens mounted in the flash-head assembly. The equipment required to complete the system, such as batteries, power supplies, timer, and synchronizing circuitry, is contained in the environmentally controlled equipment racks or boxes mounted around the interior of the forward skirt structure. The combined timer and synchronizing unit serves

SATURN V NEWS REFERENCE

two functions. The digital pulse timer supplies real time correlation pulses which are printed on one edge of the film. The timer also supplies event marker pulses to the opposite edge of the film to record selected significant events such as liftoff, engine shutdown, and stage separation. The synchronizing unit times the intermittent illumination provided by the strobe lamps to coincide with the open portion of the rotating shutter as it passes the motion picture film gate. The capsule assembly consists of the heavy nose section and quartz window, which protect the capsule during re-entry heating and impact on the water. The body of the capsule, including the camera, is sealed and watertight. A paraloon and drag skirt aid its descent and flotation. A radio beacon and flashing light are mounted on the capsule to aid in recovery.

TELEVISION SYSTEM

The television system on the first stage will transmit four views of engine operation and other engine area functions in the interval from fueling to first

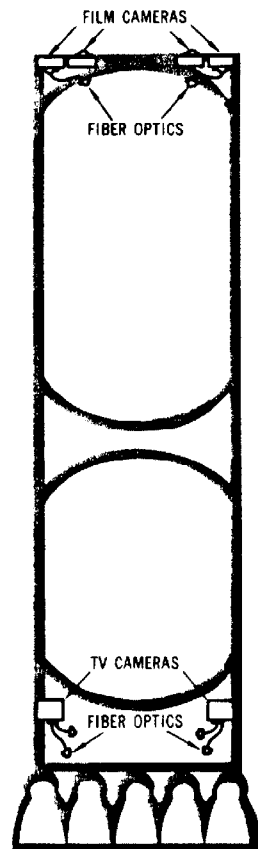

Visual Instrumentation

stage separation. The system utilizes two split fiber optics viewing systems and two cameras. Extremes in radiant heat, acoustics, and vibration prohibit the installation of the cameras in the engine area; therefore, fiber optics bundles are used to transmit the images to the cameras located in the thrust structure. Quartz windows are used to protect the lens. Both nitrogen purging and a wiping action are used to prevent soot buildup on the protective window.

Image enhancement improves the fiber-optical systems by reducing the effects of voids between fibers and broken fibers. An optically flat disc with parallel surfaces rotates behind each objective lens.

The drive motor rotates in synchronism with the master drive motor. A DC to AC inverter energizes the synchronous drive motors. A camera control unit houses amplifiers, fly back, sweep, and other circuits required for the video system. Each vidicon output (30 frames/second) is amplified and sampled every other frame (15 frames/second) by the video register. A 2.5 watt FM transmitter feeds the 7-element yagi antenna array covered by a radome.

FIRST STAGE FLIGHT

The first stage is loaded with RP-1 fuel and LOX at approximately 12 and 4 hours respectively, before launch. With all systems in a ready condition, the stage is ignited by sending a start signal to the five F-1 rocket engines. The engine main LOX valves open first allowing LOX to begin to enter the main thrust chamber. Next the engines' gas generators and turbopumps are started. Each engine's turbopump assembly will develop approximately 60,000 horsepower. Combustion is initiated by injecting a hypergolic solution into the engine's main thrust chamber to react with the LOX already present. The main fuel valves then open, and fuel enters the combustion chamber to sustain the reaction previously initiated by the LOX and hypergolic solution. Engine thrust then rapidly builds up to full level. The five engines are started in a 1-2-2 sequence, the center engine first and opposing outboard pairs at 300-millisecond stagger times. The stage is held down while the engines build up full thrust. After full thrust is reached and all engines and stage systems are functioning properly, the stage is released. This is accomplished by a "soft release" mechanism. First, the restraining hold-down arms are released. Immediately thereafter the vehicle begins to ascend but with a restraining force caused by tapered metal pins being pulled through holes. This "soft release" lasts for about 500 milliseconds.

SATURN V NEWS REFERENCE

The vehicle rises vertically to an altitude of approximately 430 feet to clear the launch umbilical tower and then begins a pitch and roll maneuver to attain the correct flight azimuth. As the vehicle continues its flight, its path is controlled by gimbaling the outboard F-1 engines consistent with a preprogrammed flight path and commanded by the instrument unit.

At approximately 69 seconds into the flight, the vehicle experiences a condition of maximum dynamic pressure. At this time, the restraining drag force is approximately equal to 460,000 pounds.

At 135.5 seconds into the flight most of the LOX and fuel will be consumed, and a signal is sent from the instrument unit to shut down the center engine. The outboard engines continue to burn until either LOX or fuel depletion is sensed. LOX depletion is signaled when a "dry" indication is received from

at least two of the four LOX cutoff sensors; one sensor is located near the top of each outboard LOX suction duct. Fuel depletion is signaled by a "dry" indication from a redundant fuel cutoff sensor bolted directly to the fuel tank lower bulkhead. The LOX depletion cutoff is the main cutoff system with fuel cutoff as the backup.

Six hundred milliseconds after the outboard engines receive a cutoff signal, a signal is given to fire the first stage retrorockets. Eight retrorockets are provided and each produces an average effective thrust of 88,600 pounds for 0.666 seconds. The first stage separates from the second stage at an altitude of about 205,000 feet. It then ascends to a peak altitude near 366,000 feet before beginning its descent. While falling, the stage assumes a semistable engines down position and impacts into the Atlantic Ocean at approximately 350 miles down range of Cape Kennedy.